

Article number: 01010451
 Description: Retaining ring A 28 DIN 471
 Stainless 411
 Note: Fitted with ZGA pilers

Measures

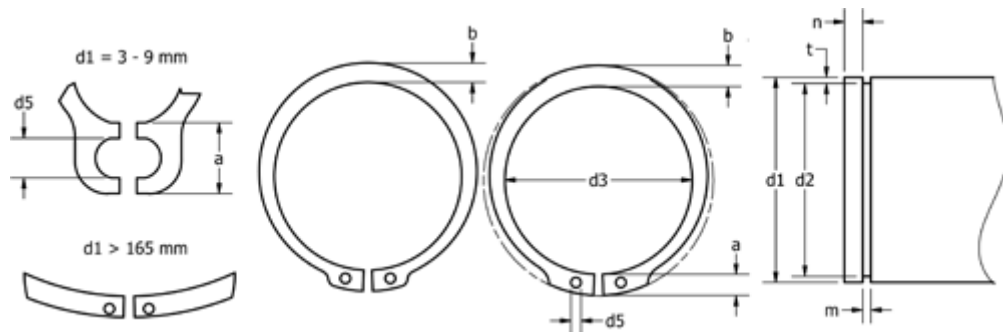

a max	= 4.7	FN kN	= 10.0	s	= 1.50
AN mm ²	= 60.0	FRg kN	= 7.50	t	= 0.70
b	= 3.2	FR kN	= 32.10	tol	= -0.21
d1	= 28	g	= 1.5	tol	= -0.06
d2	= 26.6	K kN-mm	= 65.00	tol	= +0,21-0,42
d3	= 25.9	m min	= 1.60	Tong	= ZGA-2
d5 min	= 2.0	n abl x 1000	= 21.0	Weight kg/1000	= 2.920
Description	= A28	Nominal drive	= 2.1		